

Optimizing 100% Outside Air Systems with Heat Pipes

*Dr. Michael K. West, PE¹
Dr. Richard S. Combes, PE²
Advantek Consulting / Melbourne, Florida*

Introduction

To meet increasingly rigorous building codes and standards, today's ventilation systems must become more sophisticated. For example, sensible cooling loads are being reduced as codes require tighter, more energy efficient construction and equipment, and ventilation requirements are tightening. Consequently, latent loads are becoming more significant in overall HVAC load calculations, and in many instances, the design load Sensible Heat Ratio is now below 0.60. This paper addresses the use of heat pipes as a 100% outside air conditioning design solution for new buildings conforming to ASHRAE Standards 62.1-2010³ and 90.1-2010⁴, and as a means to improve HVAC performance, Indoor Air Quality (IAQ), and energy efficiency in existing buildings.

HVAC design for all commercial buildings must address effective ventilation with fresh air as required by ASHRAE Standard 62.1, where the most recent version of the standard is incorporated in codes, and in projects aiming for LEED certification. Meeting ASHRAE Standard 90.1-2010 requires the design of energy efficient HVAC systems, and it generally does not allow cooling and reheating of the same airstream. However, 90.1 does specifically allow for reheating with recovered energy such as wrap-around heat pipes. 100% outside air systems have been used for years in specialty buildings such as laboratories and clinics. Many designers are now using these Dedicated Outside Air Systems (DOAS) for buildings such as schools and offices as a cost-effective and energy efficient approach to meeting 62.1-2010 requirements.

Background

The concept of heat transfer through the capillary movement of working fluids was patented in 1942, and the application of heat pipe technology was developed by federal agencies. Early in the U.S. space program, NASA employed heat pipes as a means of

¹ Michael West, PhD, PE is a principal HVAC systems scientist with Advantek Consulting. He is responsible for the development and testing of new HVAC technologies, as well as the engineering of energy-efficiency and indoor-environmental-quality projects throughout the United States and the Caribbean.

² Richard Combes, PE, PhD has managed numerous commercial building HVAC application projects, and is currently working on a U.S. Department of Defense project, under the Energy Saving Technology Certification Program, to demonstrate new technology for commercial unitary HVAC systems.

³ ANSI/ASHRAE 62.1-2010, "Ventilation for Acceptable Indoor Air Quality," copyright 2010 by American Society of Heating, Refrigeration, and Air Conditioning Engineers, Inc., 1791 Tullie Circle NE, Atlanta, GA 30329, http://www.techstreet.com/standards/ashrae/62_1_2010?product_id=1720986.

⁴ ANSI/ASHRAE 90.1-2010, "Energy Standard for Buildings Except Low-Rise Residential Buildings," copyright 2010 by American Society of Heating, Refrigeration, and Air Conditioning Engineers, Inc., 1791 Tullie Circle NE, Atlanta, GA 30329, http://www.techstreet.com/standards/ashrae/90_1_2010_si?product_id=1739527.

dealing with heating from the sun-exposed side of a non-rotating spacecraft that threatened failure of heat-sensitive electronics. Other heat pipe applications include dissipating heat from oil being transported in the Trans-Alaskan Pipeline to avoid thawing the permafrost foundation supporting the pipeline, and in evacuated tube solar thermal water heating systems. Heat pipes have been used for over sixty years in HVAC energy recovery applications, such as medical and laboratory facilities, and manufacturing processes. The basic heat pipe is a passive refrigeration system that transfers thermal energy from one end of the pipe to the opposite end (Figure 1).

Figure 1 - Basic Heat Pipe

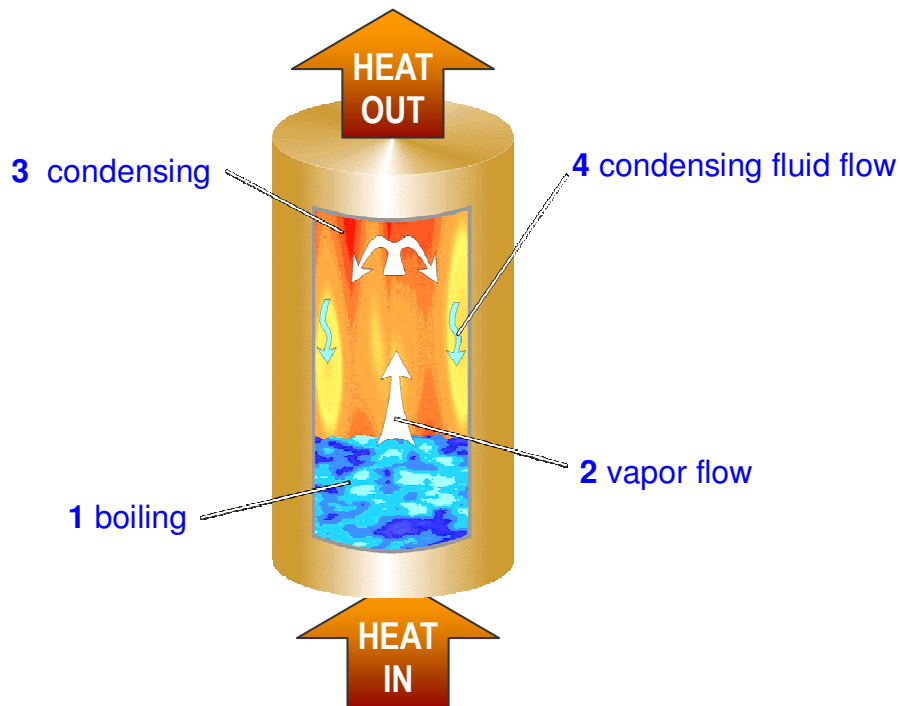

In 1986, a unique application of heat pipes for improved dehumidification in air conditioning was developed by Heat Pipe Technology, Inc. (HPT), Gainesville, FL. Figure 2 shows how the new application took a straight heat pipe module and wrapped it around an air conditioning cooling coil, allowing forced air flow from the supply fan to first go through the portion of the heat pipe upstream of the cooling coil (the pre-cool section), then through the cooling coil, and finally through the downstream portion of the heat pipe (the reheat section). Entering air temperature is reduced by 5 to 20 degrees F by the pre-cool section, allowing the evaporator coil to condense more water vapor, due to the lower entering wet-bulb temperature. Then the reheat section of the heat pipe raises the cooling coil exit temperature by at least the same 5 to 20 degrees F. When added to a conventional DX or chilled water cooling system, a wrap-around heat pipe can significantly increase dehumidification with the only additional energy usage being the fan energy needed to force air through the precool and reheat sections (Figure 2.). Heat pipe coils are sealed, with no moving parts, and their application has been refined to provide DOAS dehumidification systems that are more energy efficient and cost-effective than competing technologies for many projects.

Design Issues for 100% Outside Air Systems

As buildings become tighter and more energy efficient, the sensible-to-latent load ratio drops below conventional equipment limits. Outside air requirements have expanded to address ventilation effectiveness at the occupant level, rather than airflow at the system level. Conventional mixed air VAV systems are sometimes proving inadequate for humidity control and for effectively ventilating with verifiable outside air quantities. A particularly successful design approach is to treat and distribute outside ventilation air with separate equipment and ductwork – a Dedicated Outside Air System (DOAS). A DOAS is designed to satisfy 100% of the outside air (OA) ventilation requirements, as established by ASHRAE 62.1, using a separate cooling / heating / filtration and distribution system. Supply air from a DOAS can be introduced directly into the conditioned space to mix with air from the recirculating HVAC system, or can be ducted to mix with recirculating air, and the mixed air is discharged into the space. Use of a DOAS results in a smaller, simpler recirculating HVAC system.

When designing a wrap-around heat pipe for a DOAS application, the desired discharge air temperature and relative humidity can be achieved by either modulating the refrigerant flow in the heat pipe, or the air flow through the pre-cool and reheat sections. This design flexibility allows the engineer to achieve a range of DOAS discharge conditions, including neutral air, in a variety of configurations. Neutral air is conditioned ventilation air supplied at the space dry bulb temperature and at a dew point low enough to maintain the space at the desired relative humidity, when allowing for latent loads generated in the space and from building envelope infiltration.

Figure 2 – Wrap-around Dehumidifier Heat Pipe Schematic

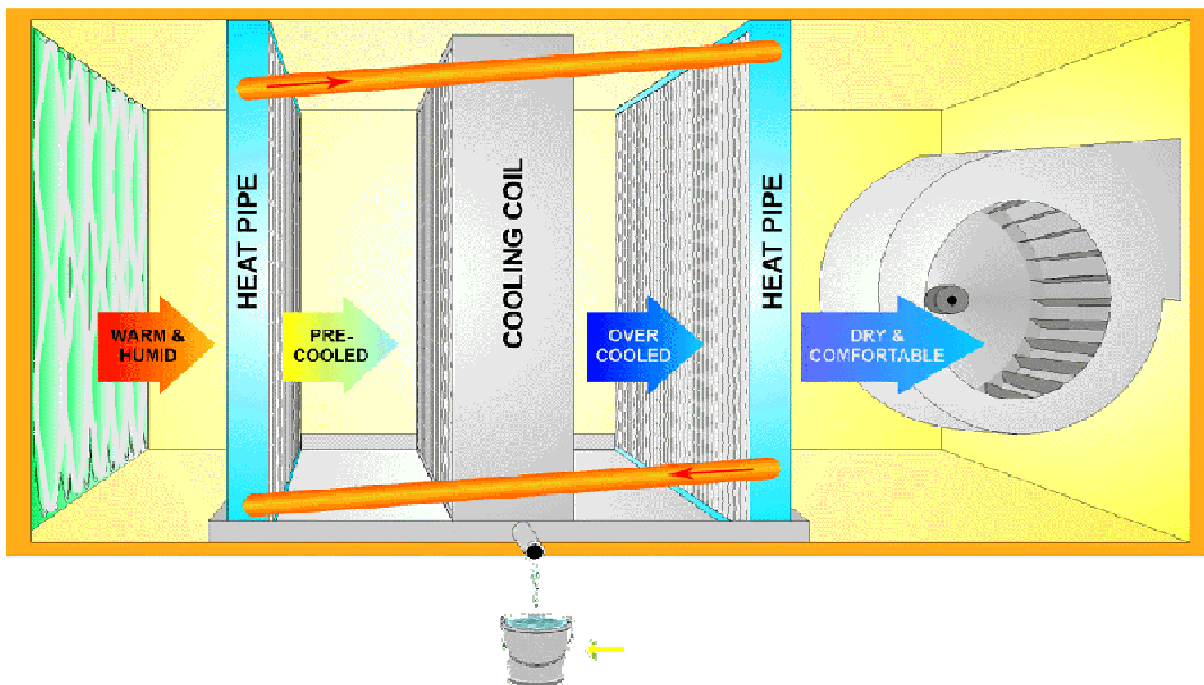

DOAS designs can provide the following operating characteristics:

- Capacity to modulate the dew point of the conditioned OA so that the entire building latent load (ventilation air latent load + internal latent loads) is satisfied by the DOAS. Then a recirculating HVAC system handles only the remaining building sensible load.
- The DOAS discharge air can be at or lower than the space set point temperature. During most of the cooling season the dew point of the DOAS discharge will be lower than the dew point of supply air from the sensible load HVAC system. Thus, when supply air from the DOAS and the recirculating system are mixed, the dew point differential of the two airflows will achieve the design temperature and relative humidity of the conditioned space.

DOAS discharge air that is below the space set point temperature may require reheat to avoid overcooling and diffuser condensation problems at low sensible building loads. To address this part-load requirement, designers are applying the concept of neutral air, where DOAS supply temperature is the same as space temperature (space neutral), while the DOAS discharge dew point is low enough to control relative humidity when ventilation air is introduced and mixed in the conditioned space.⁵

Figure 3 is an example of a DOAS supplying near-neutral air to a space to be maintained at 75 F and 50% RH. The design air state points on the psychrometric chart are matched to the schematic of the DOAS and the recirculating air conditioning units, and the design values for conditioned air are the following:

- Outside air is at 85 F dry bulb, 72 F wet bulb.
- DOAS conditions outside air and supplies it at 69 F dry bulb, 50 F dew point.
- The recirculating units take air from the conditioned space at 75 F dry bulb, 55 F dew point (62.7 F wet bulb), and supply it at 69 F dry bulb, 60 F wet bulb (55 F dew point).
- The design dew point temperature of DOAS supply air would be further reduced to meet internal moisture loads from occupants, activities and processes, as needed.
- The recirculating supply air temperature would be further reduced to meet the sensible cooling load, as needed.
- Conditioned air from the DOAS can be modulated to reflect the occupancy of the conditioned space and the resulting ventilation effectiveness is maintained independent of the recirculating HVAC system operation.

DOAS applications will require reheating of conditioned air to achieve neutral air conditions, especially in high humidity climates. In practice, DOAS supply air can be provided at any temperature between the 55 F dew point and the 75 F space

⁵ Brooke, Tom, P.E., CEM, (2007) "Neutral Air Units with Heat Pipes in Chilled Water Systems," http://www.heatpipe.com/mktg_materials/News_Letters/Neutral%20Air%20Units%20with%20Heat%20Pipes%20in%20Chilled%20Water%20Systems.pdf, pp. 1-2.

temperature, with the difference in sensible load (cooling or heating) met by the recirculating HVAC equipment. Heat pipes have been used with very good results in DOAS designs to reduce energy required for reheat.

Figure 3a / 3b – Example of a Neutral Air Dedicated Outside Air System (DOAS)

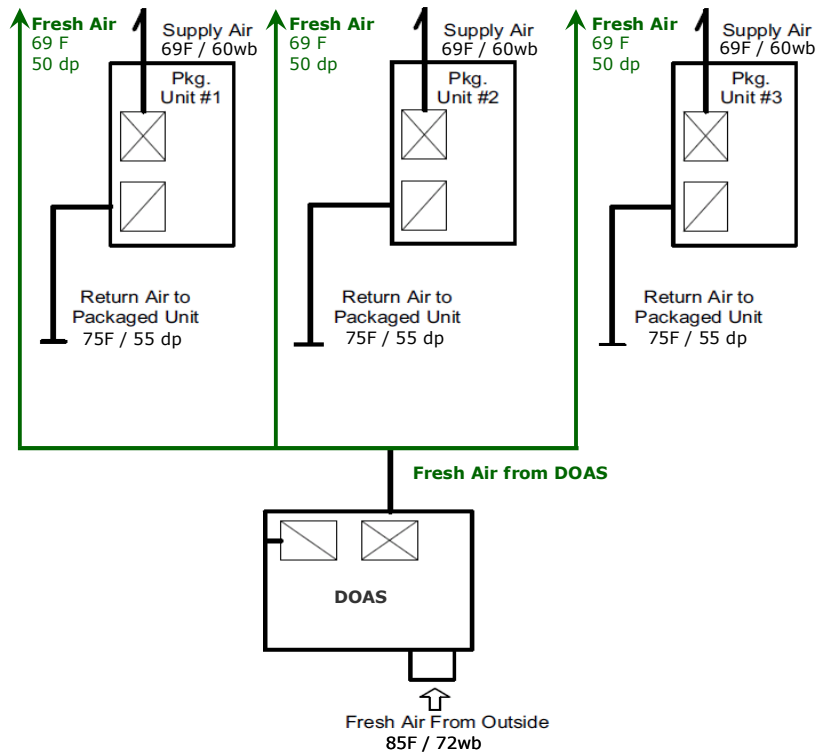
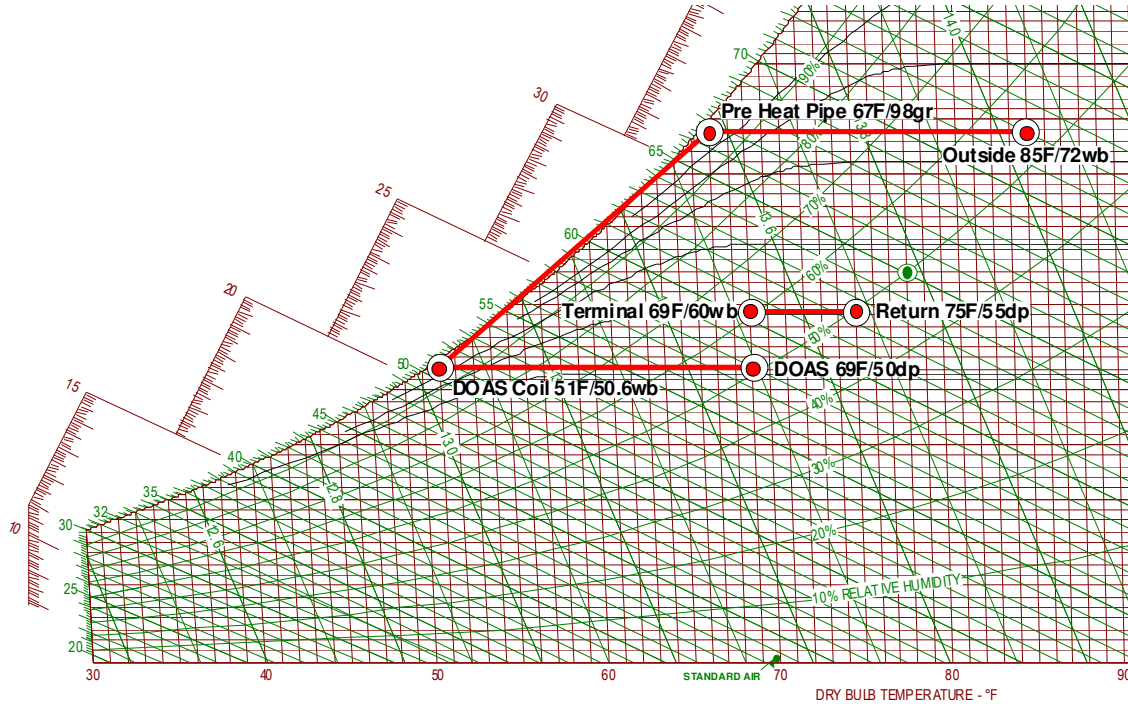

Table 1 - Cooling performance of DOAS system shown in Figure 3b.

Per Unit Coil	Airflow SCFM	Sensible Cooling Btuh	Latent Cooling Btuh	SHR	TOTAL Cooling Btuh
Terminal Unit	3,200	20,565	0	1.0	20,565
Precool Heat Pipe	1,000	18,947	0	1.0	18,947
DOAS Unit	1,000	17,223	29,846	0.37	47,069
Reheat Heat Pipe	1,000	- 18,947	0	1.0	- 18,947
TOTAL System	4,200	37,788	29,846	0.56	5.6 tons

Design Optimization of 100% Outside Air Systems

In many climate zones, annual ventilation dehumidification needs are 2 to 10 times the annual sensible loads.⁶ Treating ventilation air cannot be efficiently accomplished by conventional HVAC systems that typically operate at a 0.65 to 0.80 sensible heat ratio, that is, 65% to 80% of their capacity provides temperature reduction leaving only 20% to 35% remaining for dehumidification. Cooling coils alone can be increased in size to condense adequate water vapor to handle latent loads, but the resulting discharge temperatures are too low for introducing into the conditioned space, and energy intensive reheat is required (Figure 4).

Figure 4 - DOAS with Conventional Reheat

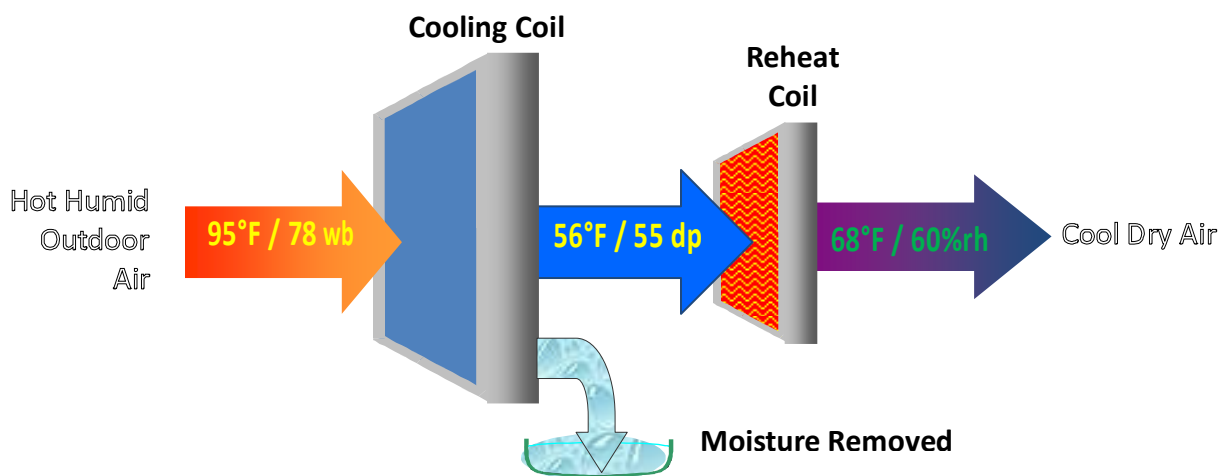

⁶ Harriman, Plager, and Kosar, “Dehumidification and Cooling Loads from Ventilation Air,” ASHRAE Journal, November, 1997; <http://www.erc.uic.edu/PDF/AJ%2011-97%20Dehumidification%20and%20Cooling%20Loads%20from%20Ventilation%20Air.pdf>

100% outside air systems with heat pipes provide adequate dehumidification, for both design values of ventilation air and internal latent loads, cost-effectively and energy efficiently. In the example shown in Figure 5, a heat pipe assembly is added to the cooling coil, providing a pre-cool section that sensibly cools outside air by 17 F and the two coils remove much more water than the cooling coil alone. On the exit side of the cooling coil, the reheat section raises the temperature by 17 F. Together with a 2 degrees F motor reheat from the supply fan, this DOAS achieves neutral air at 75 F.

As the OA temperature drops, the temperature of the heat pipe reheat section will also be reduced. The wrap-around heat pipe assembly can be sized for design conditions and it will self-modulate to provide more consistent DOAS discharge temperature and relative humidity than a cooling coil alone.

Figure 5 - Ventilation Air State Points for Neutral Air DOAS

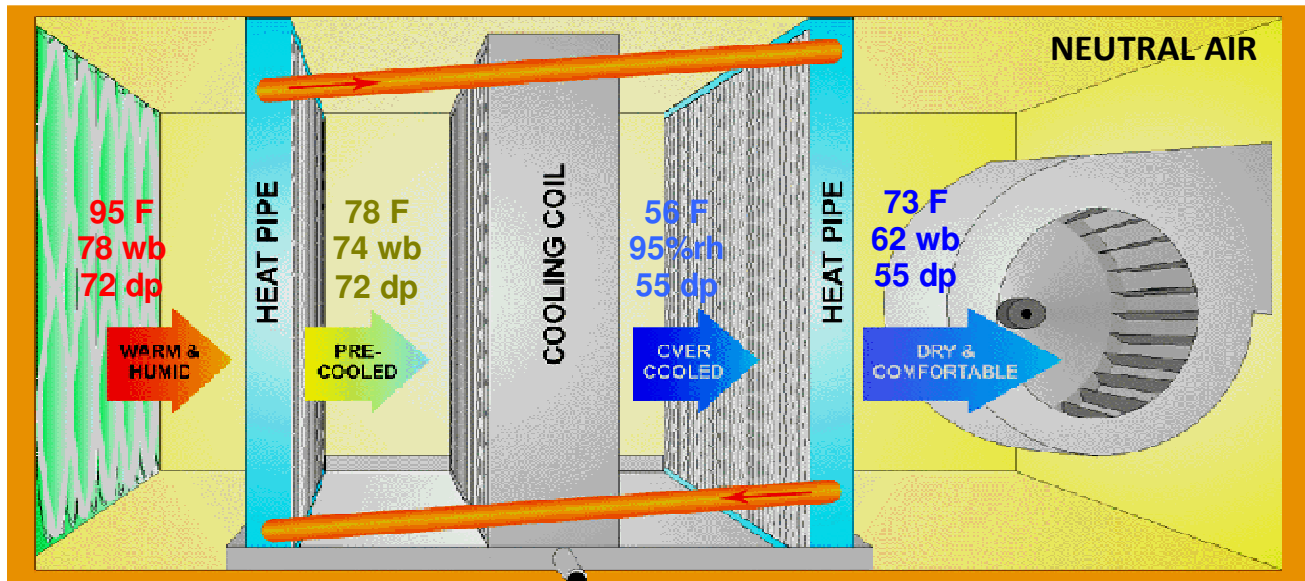

When a 100% outside air system is the design choice for a project, heat pipes can offer the design engineer an efficient means of providing neutral air or DOAS supply air at lower temperatures. The design process for heat pipe assemblies is flexible, offering reliable control of outside air treatment variables including:

- Amount of pre-cooling of outside air entering the cooling coil.
- Amount of reheat of air leaving the cooling coil.
- Heat pipe configuration (Figure 6) and fin spacing to meet face velocity and pressure drop specifications.
- Materials of construction that match the conventional DX cooling coils.
- Refrigerants to meet project specifications.

Figure 6 - Dimensional Design Options for Wrap-around Heat Pipes

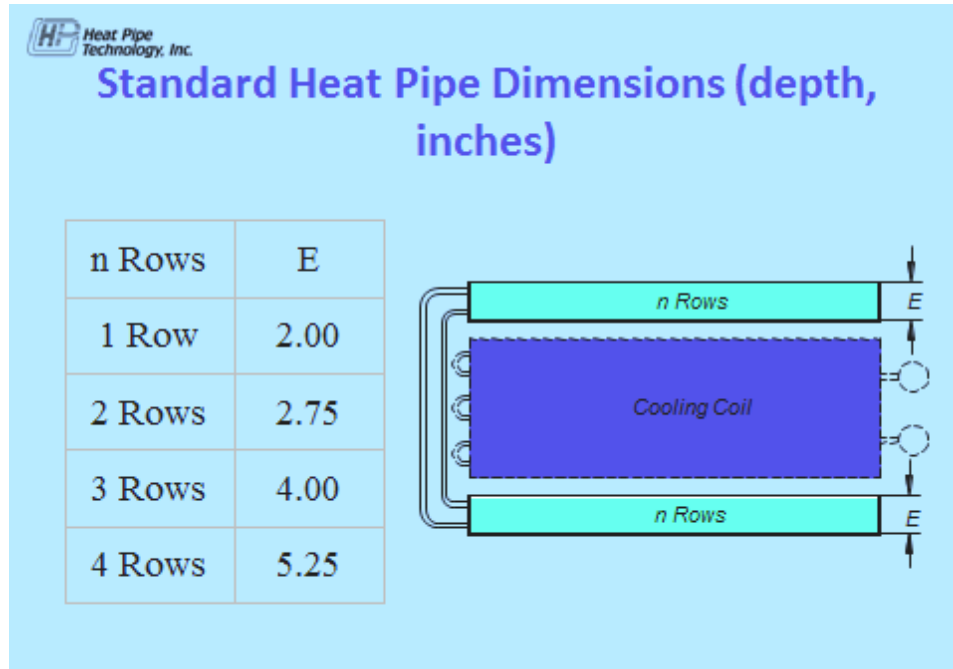

Energy Savings and Life Cycle Cost (LCC) Analysis

Heat pipe coils generate energy savings by providing sensible pre-cooling and subsequent reheat with no moving parts or energy required, other than a small amount of fan power needed to move air through the pre-cool and reheat sections. Comparing the example shown in Figure 4 with the heat pipe-equipped DOAS unit in Figure 5, typical savings include:

- Reduced size and capacity of cooling coil.
- Reduction or elimination of reheat energy.
- Lower maintenance requirements.

To perform a Life Cycle Cost (LCC) analysis of technologies providing the dehumidification capability required in a 100% outside air system, the following costs should be evaluated over the life of the equipment:

1. Capital cost for both factory-installed and site-installed applications
2. Additional parasitic fan energy costs over the operating life
3. Cooling costs from the chilled water system or DX compressor
4. Reheat energy costs
5. Maintenance & replacement costs over the expected life

The following example will compare wrap-around heat pipes with a pump-around heat exchanger system using glycol/water as the working fluid and, as with the heat pipe assembly, pre-cool and reheat heat exchangers installed before and after the cooling coil.

DOAS Design Example

Consider a DOAS application for a new building being designed to U.S. General Services Administration (GSA) standards. When using a DOAS, GSA requires that the system maintain conditioned space air at a dew point of 55 F or less, and that DOAS supply air is no less than 50 F dew point and no less than 52 F dry bulb.⁷ In the following example, these design guidelines are used to compare a small DOAS with wrap-around heat pipes to a DOAS with a glycol/water pump-around heat exchanger.

The following design details are used in the comparative analysis. The psychrometric state points for the heat pipes and the pump-around system are the same.

1. DOAS supplies 5,000 cfm of outside air conditioned to a neutral air state of 75 F dry bulb, 50% rh / 55 F dew point / 62.5 F wet bulb / 65 gr/lb
2. Design OA is at 95 F dry bulb / 78 F wet bulb / 47%rh / 71.8 F dew point / 117 gr/lb
3. Discharge air is at 73.2 F dry bulb / 61.9 F wet bulb, with a 1.8 degrees F of motor reheat to give supply air of 75 F dry bulb / 62.5 wet bulb / 50%rh / 55 F dew point / 64.9 gr/lb
4. Configuration, per side, for pump-around system is 6 rows of tubes with 11 fins/inch, and for heat pipes is 4 rows with 10 fins/inch. Heat pipe heat exchangers are smaller than glycol/water exchangers due to better heat transfer.
5. DOAS cooling coil is DX using R410a.

Capital Costs Compared

The installed cost of the pump-around system is estimated to be \$5,700, while the installed cost of the heat pipe system is estimated to be \$7,000, assuming a factory installation. A site-installed heat pipe system would have somewhat higher cost, which is assumed to be offset by reduced shipping cost.

The heat pipe system is designed for the specified DOAS supply dew point of 55 F and, for varying cooling and dehumidification demands, the system can be modulated by controlling either refrigerant flow or using a bypass damper. Adding controls to the system increases the capital cost.

⁷ U.S. General Services Administration, (2010), *Facilities Standards for Public Buildings (P100)*, Chapter 5.3 "HVAC Performance Characteristics/Occupant Health and Comfort/Ventilation," and Chapter 5.8 "HVAC Components/Air-Handling Units/Limitation of Supply Air Temperature."

Energy Costs Compared

With the same supply fan for both applications, the additional fan energy needed for pressure drop through each heat exchanger is:

Pump-around system	0.44 inches H ₂ O (per side)
Heat pipe system	0.28 inches H ₂ O (per side)

In addition, the pumping friction loss for recirculating glycol/water in the pump-around system amounts to 10.3 feet of head (per side). The heat pipes are passive, requiring no significant energy to circulate the working fluid (refrigerant). The energy requirements for the two systems are:

Pump-around system	1.28 bhp (fan + pump)
Heat pipe system	0.73 bhp (fan only)

Both systems operate for 3,000 hours/year; the fan/motor combination is 54% efficient and the pump/motor combination is 72% efficient (motors are 90% efficient); and 2011 electricity costs is \$0.095/kWh, with a monthly demand charge of \$7.45/kW, resulting in annual energy costs of:

Pump-around system	\$397
Heat pipe system	\$228

Life Cycle Cost Comparison

To compare the two systems, the above annual energy costs are used. The installed capital cost is assumed to be \$5,700 for the glycol/water pump-around system, and \$7,000 for the heat pipe system. The only additional cost assumed for comparing the two systems is annual maintenance, since both have a nominal 15-year lifetime. The pump-around system is assumed to need maintenance of pumps and valves, as well as labor to clean the coils, fix leaks, and monitor the glycol/water solution. This annual maintenance cost is assumed to be \$310. The heat pipe system has no moving parts and the only maintenance assumed is \$100 for annual coil cleaning and occasional solenoid valve parts replacement.

To evaluate Life Cycle Costs (LCC) of both systems, the U.S. Department of Energy's Building Life Cycle Cost modeling software, BLCC 5⁸, was used. The project was assumed to be located in Georgia and the life of both systems was assumed to be 15 years, with a 1% salvage value. Using the assumptions listed in Table 2, the LCC of each system is:

Pump-around system	\$14,763
Heat pipe system	\$11,075

⁸ Software description and free download at http://www1.eere.energy.gov/femp/information/download_blcc.html

Table 2 - Variables used in LCC analysis

System	Pressure drop/side: Supply Fan	Pressure drop/side: Recirc Pump	Fan Power	Annual Energy Cost*	Annual O&M Cost
Glycol/water	0.44 in. H ₂ O	10.3 ft H ₂ O	1.28 bhp	\$397	\$310
Heat Pipe	0.28 in. H ₂ O	none	0.73 bhp	\$228	\$100

* At 3,000 hours annual operation, \$0.095/kWh, monthly demand charge of \$7.45/kW

This analysis indicates the life cycle cost of the heat pipe system is 25% less than that of a comparable glycol/water pump-around system.

Conclusions

Heat pipe wrap-around coils are cost effective, energy efficient, and straightforward to apply to 100% outside air designs to help the designer meet ASHRAE Standards 62.1-2010 and 90.1-2010 in new buildings, and to improve HVAC performance, Indoor Air Quality (IAQ) and energy efficiency in existing buildings by increasing dehumidification and/or ventilation effectiveness.

Heat pipes reduce entering outside air temperature by 5 to 20 degrees F before it enters the cooling coil and provide 5 to 20 degrees F reheat downstream of the cooling coil with relatively little energy use. Heat pipes are passive, requiring a small amount of additional fan power to overcome the pressure drop through the heat pipe fin-tube coils. By pre-cooling the outside airflow entering the cooling coil, more water vapor is removed by the cooling coil, and the downstream reheat section produces supply air that is closer to neutral air conditions.

Controllable heat pipes have the ability to modulate the dewpoint of the conditioned OA so that the entire building latent load (ventilation air load + internal latent loads) is satisfied by a DOAS and a recirculating HVAC system handles only the remaining building sensible load.

The design process for heat pipe applications is flexible, offering reliable control of all outside air treatment variables. The heat pipe equipped system will have a smaller cooling coil, use little or no new reheat energy, and have no added maintenance requirements.

Factory or field installations of heat pipe systems around cooling coils offer customers a highly reliable and low-maintenance system for controlling building latent loads and indoor air quality. With even relatively small DOAS applications, as in the above example, heat pipes are more cost effective than pump-around glycol/water systems, and the life cycle cost advantage grows with the scale of the DOAS. Building owners and engineers should consider the use of heat pipes in all DOAS applications, particularly in high latent load regions, or in energy efficient buildings with low sensible loads.